

# HPE Aruba Networking AP-ANT-340 antenna for indoor access points



## Dual-polarized tri-band 4-element low-profile down-tilt-omni antenna (RP-SMA, cabled) for indoor use

The AP-ANT-340 antenna is a tri-band, 4-element, dual-polarized low-profile down-tilt omnidirectional antenna, intended for discrete ceiling mounted applications, providing coverage for access in 2.4GHz, 5GHz and/or 6GHz concurrently.

The AP-ANT-340 mounts directly to the suspended ceiling tile.

### Specifications

#### Frequency bands, ranges, and peak gains

|        |                   |      |
|--------|-------------------|------|
| 2.4GHz | 2.400GHz–2.500GHz | 4dBi |
| 5GHz   | 5.100GHz–5.900GHz | 5dBi |
| 6GHz   | 5.900GHz–7.150GHz | 5dBi |

#### Polarization

Linear, Vertical

#### Pattern beamwidth (3dB)

|        |  |
|--------|--|
| 2.4GHz | Elevation (V): ~80 degrees (40° downtilt) Azimuth (H): 360 degrees |
| 5GHz   | Elevation (V): ~60 degrees (40° downtilt) Azimuth (H): 360 degrees |
| 6GHz   | Elevation (V): ~40 degrees (40° downtilt) Azimuth (H): 360 degrees |

#### Input impedance

50 Ohms

#### Maximum input power

2 Watts

#### VSWR

< 2.0:1

#### Port isolation

|        |      |
|--------|------|
| 2.4GHz | 18dB |
| 5GHz   | 18dB |
| 6GHz   | 18dB |

### Dimensions

177.8mm (D) x 32mm (H)  
(antenna itself)

214mm (L) x 214mm (W) x 118mm (H)  
(as it ships)

### Weight

0.4kg (antenna itself)

0.62kg (as it ships)

### Radome

Material: PC/ABS, UV resistant

Color: White

### Fly cable length& type/connector

75±1.8cm Plenum Rated  
RG58LL/ RP-SMA-Male (x4)

### Operating temperature range and relative humidity

-40°C to +70°C (temp)

TBD (humidity)

### Water and dust protection (IP rating)

IP20

### Wind speed

Not applicable—indoor use only

### Lightning protection

DC short circuit

### Installation hardware

The primary mounting method for drywall or tile flush mount uses the threaded post on the back of the antenna and supplied mounting nut. The post protrudes through the tile or drywall material and feeds the four RF cables. Alternatively, the antenna can be attached directly to a solid wall or ceiling surface using additional hardware supplied with the antenna.

### Shipping content

Antenna, mounting hardware and instruction manual included in unit carton.

### Antenna patterns (typical for all four antenna elements)

Horizontal (azimuth) plane (top view) & Vertical (elevation) planes (front/side view)

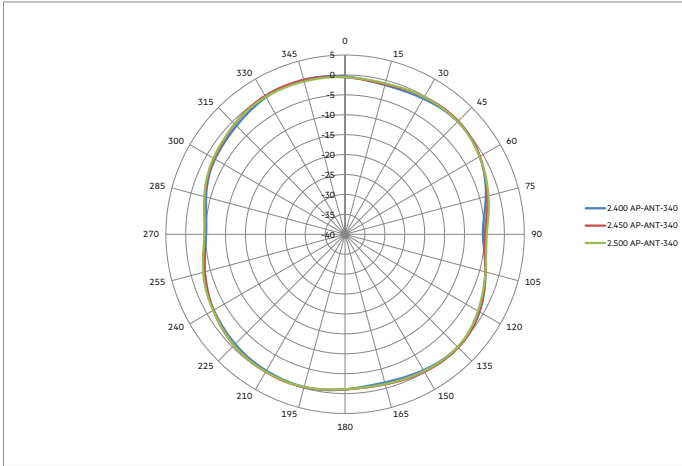

2.4GHz antenna patterns (horizontal)

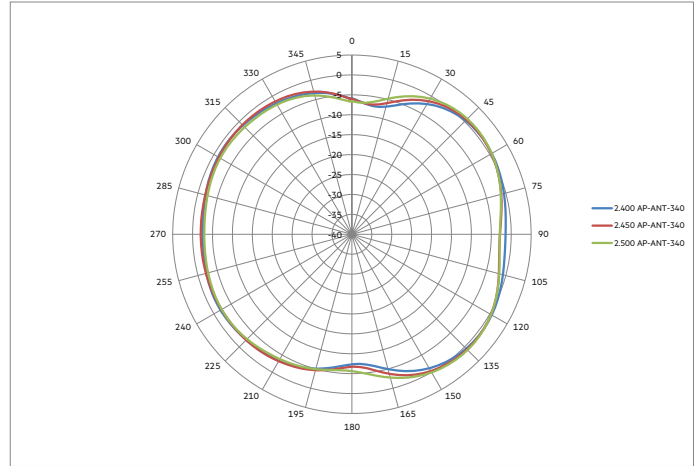

2.4GHz Antenna patterns (40° downtilt horizontal)

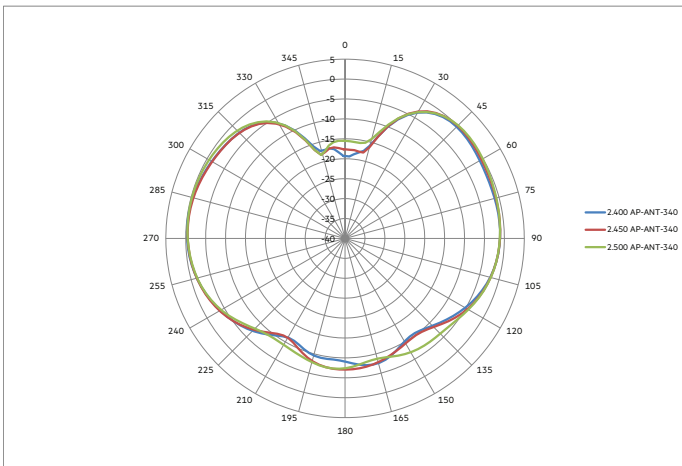

2.4GHz antenna patterns (vertical/0)

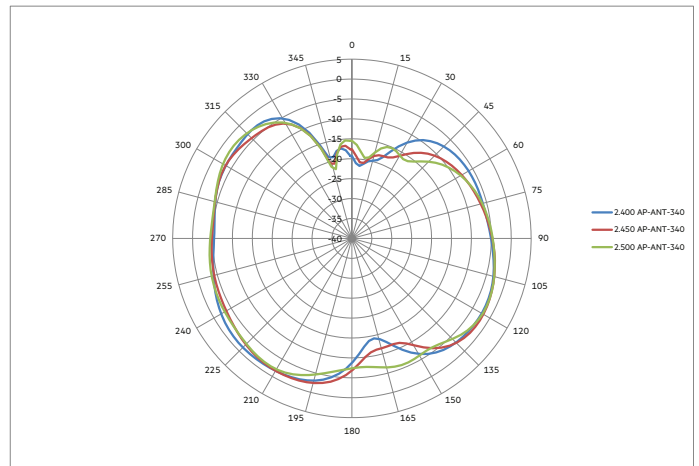

2.4GHz antennas patterns (vertical/90)



### Antenna patterns (typical for all four antenna elements)

Horizontal (azimuth) plane (top view) & Vertical (elevation) planes (front/side view)

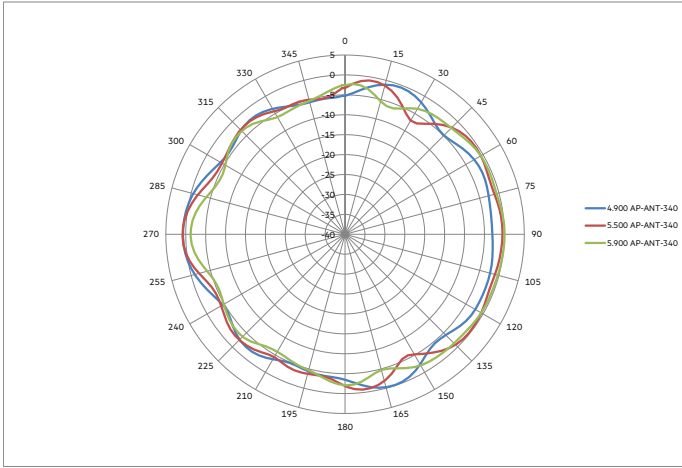

5GHz antenna patterns (horizontal)

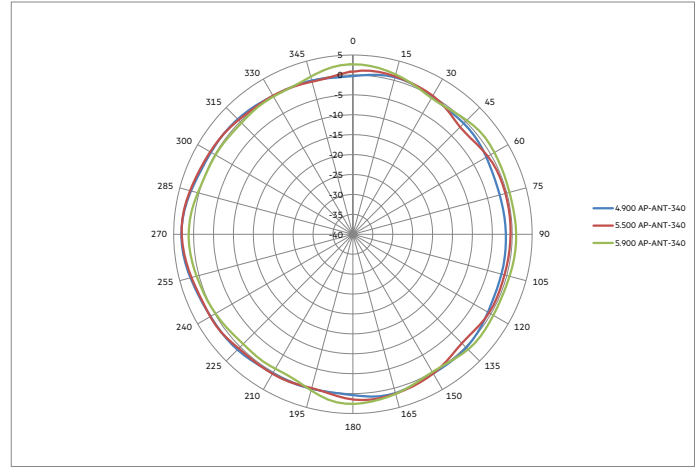

5GHz Antenna patterns (40° downtilt horizontal)

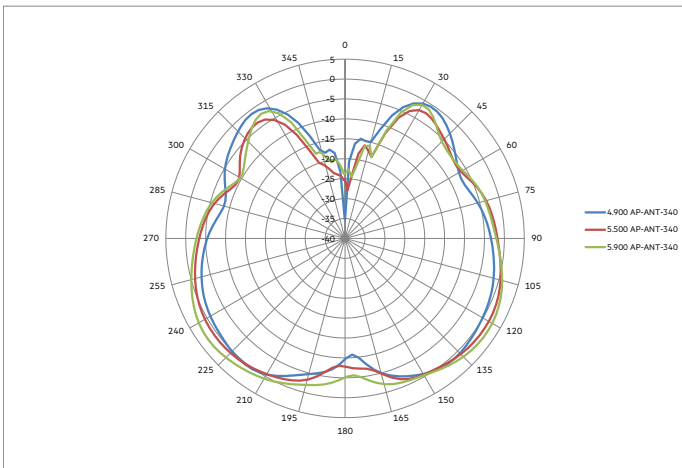

5GHz antenna patterns (vertical/0)

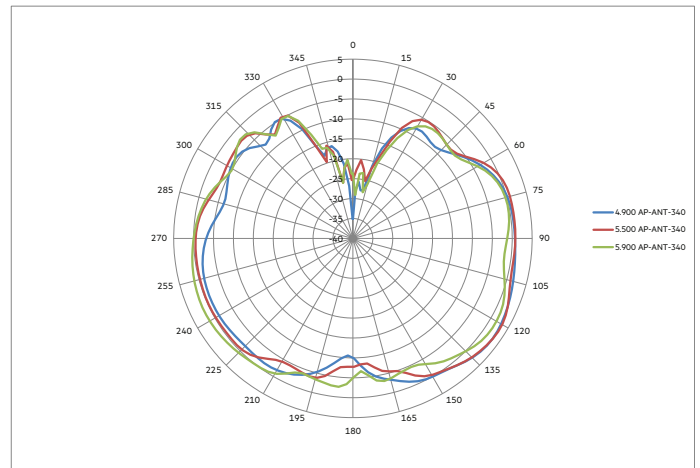

5GHz antennas patterns (vertical/90)



### Antenna patterns (typical for all four antenna elements)

Horizontal (azimuth) plane (top view) & Vertical (elevation) planes (front/side view)

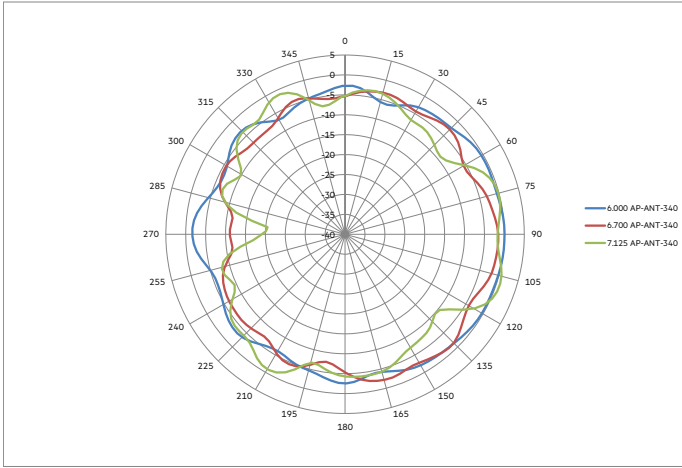

6GHz antenna patterns (horizontal)

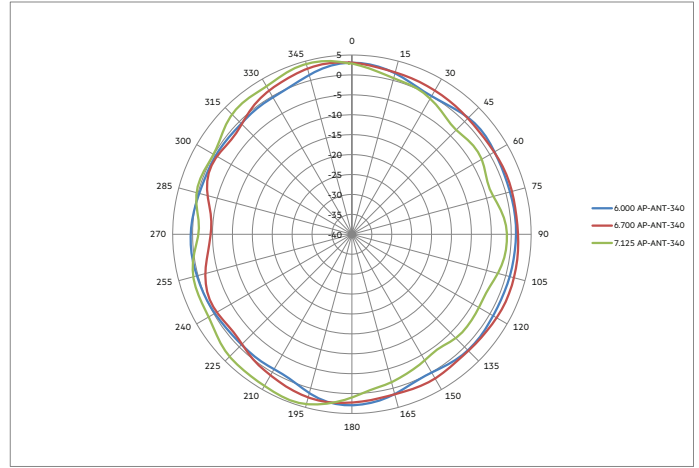

6GHz Antenna patterns (40° downtilt horizontal)

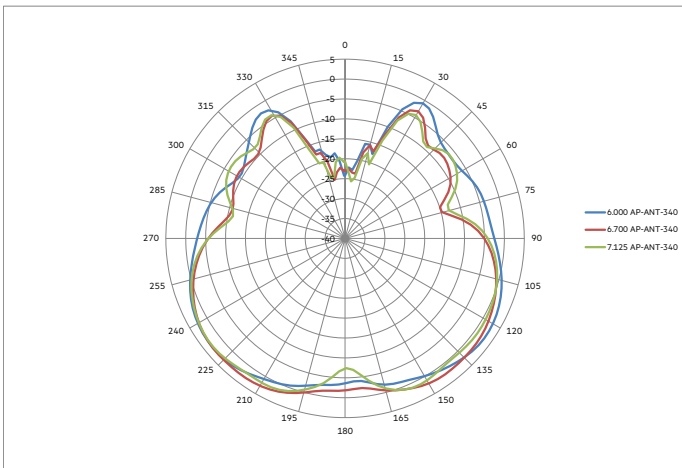

6GHz antenna patterns (vertical/0)

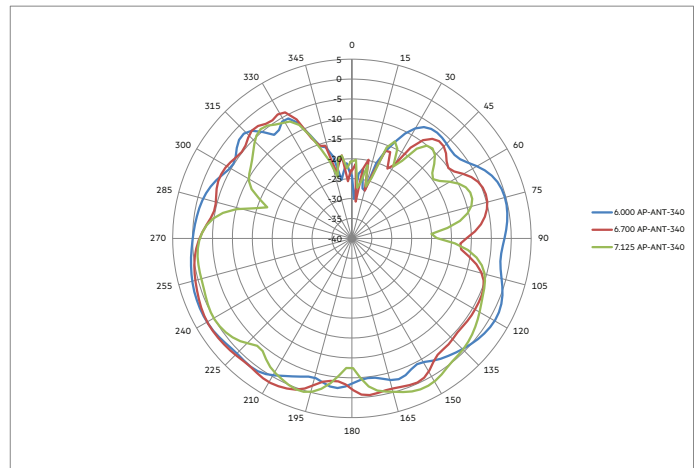

6GHz antennas patterns (vertical/90)



## Mechanical drawings

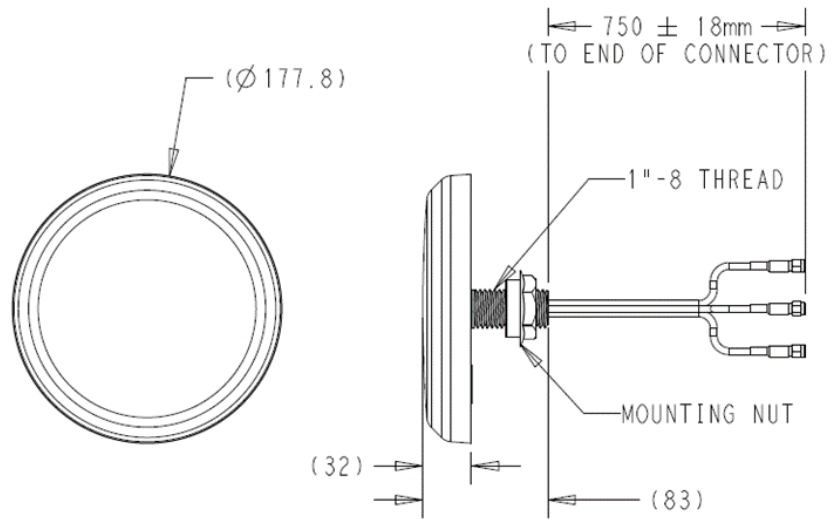

## Ordering information

| Part number  | Description  |
|--|--|
| <b>HPE Aruba Networking Antennas for Indoor Access Points (RP-SMA)</b> |  |
| <b>S1F82A</b>  | HPE Aruba Networking AP-ANT-340 Cabled RP-SMA Tri-Band 4x4 Downtilt Omni Ceiling Antenna |

Make the right purchase decision.  
Contact our presales specialists.

