

HPE Aruba Networking AP-ANT-345 Antenna for Indoor Access Points



Dual-polarized cabled tri-band 4-element medium gain directional panel antenna (RP-SMA) for indoor and outdoor use.

The AP-ANT-345 antenna is a tri-band, 4-element, dual-polarized panel antenna with nominal 90° H x 90° V beamwidths and 5dBi peak gain. This antenna is well suited for indoor and outdoor sector coverage for Wi-Fi access in 2.4GHz, 5GHz and/or 6GHz concurrently.

The AP-ANT-345 can be mounted directly to a wall (or ceiling) using the supplied screws and anchors, or if more flexibility is needed it can be combined with the optional AP-ANT-MNT-U articulating wall/pole mount.

Specifications

Frequency bands, ranges and peak gains

- 2.4GHz 2.400GHz – 2.500GHz 6.1dBi
- 5GHz 4.900GHz – 5.900GHz 6.1dBi
- 6GHz 6.000GHz – 7.150GHz 5.4dBi

Polarization

- Cross Pol (Ratio – 9:1)

Pattern beamwidth (3dB)

- 2.4 GHz
Elevation (V): Approximately 79.1°
Azimuth (H): Approximately 79.3°
- 5.0 GHz
Elevation (V): Approximately 78.5°
Azimuth (H): Approximately 83.2°
- 6.0 GHz
Elevation (V): Approximately 78.0°
Azimuth (H): Approximately 80.3°

Input impedance

- 50 Ohms

Maximum input power

- 33dBm (2 Watts) per port

VSWR

- < 2:1

Port isolation

- 2.4 GHz 20 dB
- 5 GHz 25 dB
- 6 GHz 23 dB

Dimensions

- 200mm (W) x 200 mm (L) x 46.5 mm(H)
(antenna itself)
- 250mm (W) x 220 mm (L) x 58 mm (H)
(as it ships)

Weight

- 0.4 kg (antenna itself)
- 0.6 kg (as it ships)

Radome

- Material: ASA, Luran S 788T, UV
- Color: White

Fly cable length and type / connector

- 75±0.8 cm Plenum Rated RG58LL/ RP-SMA-Male (x4)

**Operating temperature range and relative humidity**

- -40°C to 65°C 10% to 95% RH

Water and dust protection (IP rating)

- IP67

Wind speed

- Up to 136 mph

Lightning protection

- N/A

Installation hardware

- There are two mounting options:
 - Wall mounting hardware kit is included
 - The antenna is also equipped with 4 x M5x0.8-6H for Articulating bracket option.

Shipping content

- Antenna, mounting hardware and instruction manual included in unit carton



Antenna patterns (averaged for all four antenna elements)

Horizontal (azimuth) plane (top view) and Vertical (elevation) plane (side view)

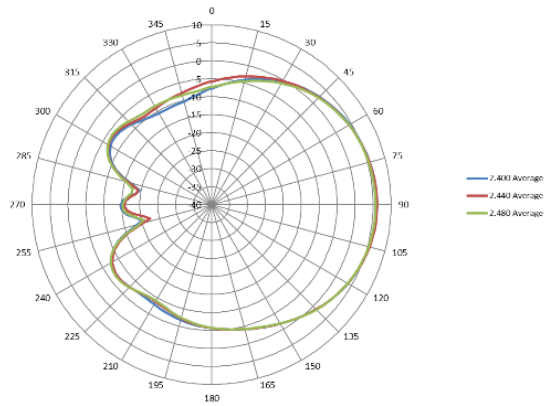

2.4GHz antenna patterns (horizontal)

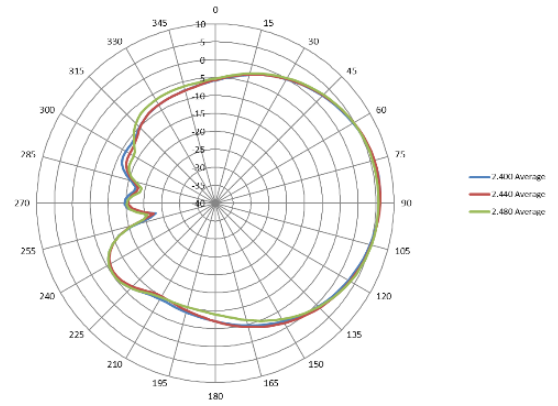

2.4GHz antenna patterns (vertical)

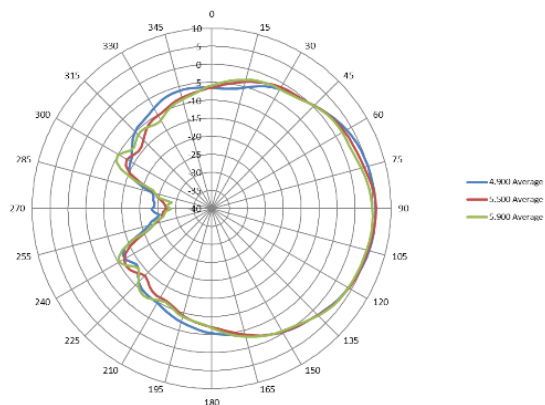

5GHz antenna patterns (horizontal)

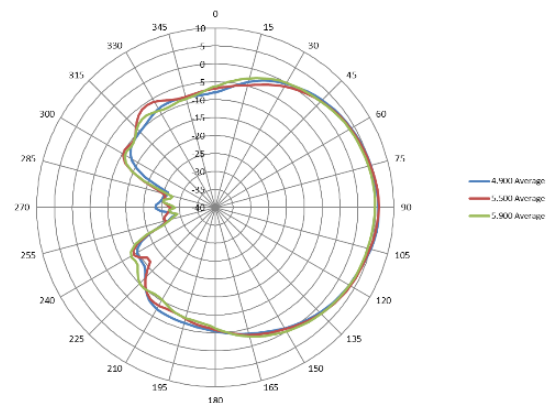

5GHz antenna patterns (vertical)

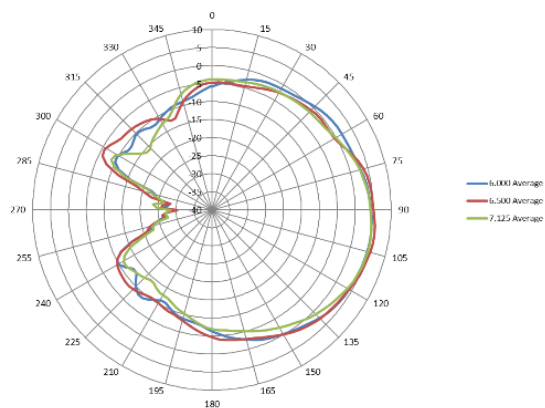

6GHz antenna patterns (horizontal)

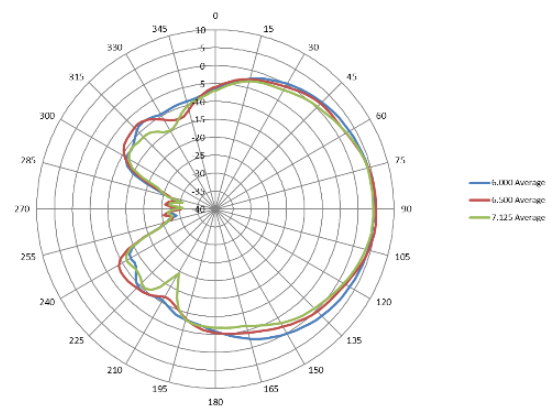

6GHz antenna patterns (vertical)



Mechanical drawings

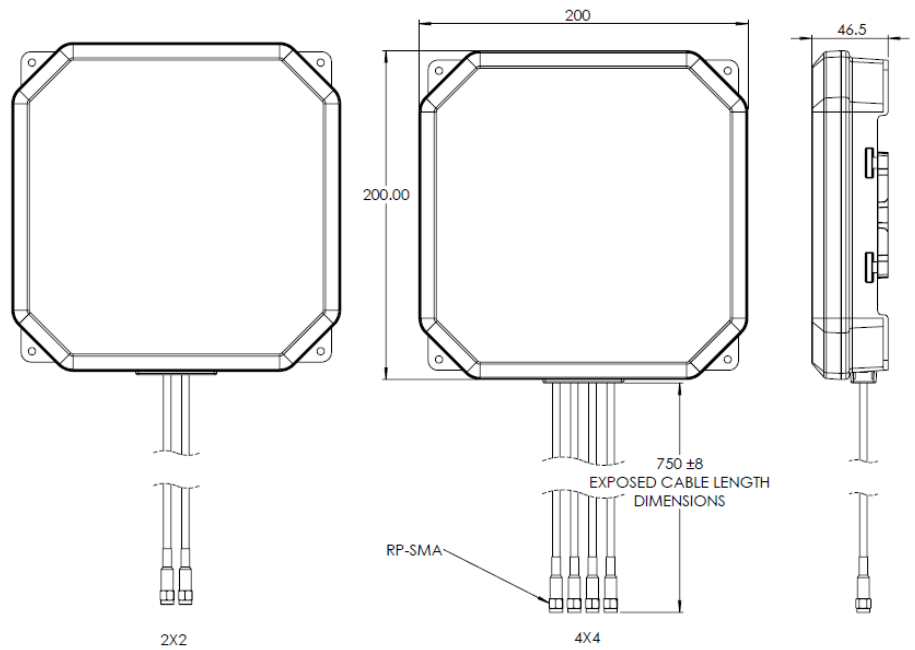

Ordering information

Part number	Description
HPE Aruba Networking Antennas for Indoor Access Points (RP-SMA)	
S1F83A	HPE Aruba Networking AP-ANT-345 Cabled RP-SMA Tri-Band 4x4 Medium Gain Directional Panel Antenna

Make the right purchase decision.
Contact our presales specialists.

